

LPI series

Tactile pushbutton switches with large actuator

Distinctive features and applications



❑ Common features

- Large ergonomic actuator (Ø 35 mm)
- Tactile feedback
- Low behind-panel depth (21 mm max.)
- Stylish design
- Long life

This series has been developed on a modular base in order to fit the exact needs of technicians and end-users.



❑ Installation options

The LPI series has a number of features to ensure easy installation:

- **Front or rear mounting**
- With or without sealing
- 2 separate circuits for NO/NC 5A version
- Terminal block connector for 0,1A NO version
- 3 different LED voltages: 6V, 12V, 24V
- Integrated LED resistor



❑ Aesthetic options

- **Ring or dot illumination**
- Wide range of LED colours
- Wide range of bezel colours
- Many different actuator types and colours

❑ Designed to meet the requirements of EN81-70

This product meets the requirements of EN81-70 and is ideal for use in all types of indoor lifts.



❑ Flexibility of marking



The company reserves the right to change specifications without notice.

LPI series

Tactile pushbutton switches with large actuator

Specifications

ELECTRICAL SPECIFICATIONS

- Snap-action, momentary function
- Mechanical life : 1.000.000 cycles min. for 5A NO/NC
5.000.000 cycles min. for 50mA NO
- Max. current/voltage rating with resistive load :

5A NO/NC version	50mA NO version
5A 12VDC - 50.000 cycles 100mA 12VDC - 1.000.000 cycles	50mA 24 VDC - 5.000.000 cycles

- Min. current with resistive load : 0,5mA at 24VDC for NO version
- Contact resistance : 100mΩ max.
- Dielectric strength : 500Vrms 50Hz between terminals
1.000 Vrms 50 Hz between terminals and ground
- Insulation resistance : 10MΩ at 500VDC
- Integrated resistors for illuminated versions
- LED current : 20mA typical for dot or ring (30mA max.)
- LED protected from reverse polarity
- Stand-by consumption : 0,5VA max.

MATERIALS

- Switch block : thermoplastic for 5A NO/NC
- Contacts :
5A NO/NC : silver, gold plated
50mA NO : silver
- Actuator crimped symbol : 304L stainless steel

MECHANICAL SPECIFICATIONS

- Environmental protection :
- IP53 for sealed version
- IP40 for unsealed version
- Impact resistance :
- IK06 for NO/NC version
- IK04 for NO version
- Operating force : 2,5 to 5N (unsealed)
- Total travel : 2 mm ±0,3 mm
- Operating temperature :
- 20°C to +65°C
- Storage temperature :
- 40°C to +70°C

PANEL CUT-OUT

Panel thickness : 1 to 4 mm (.039 to .157)

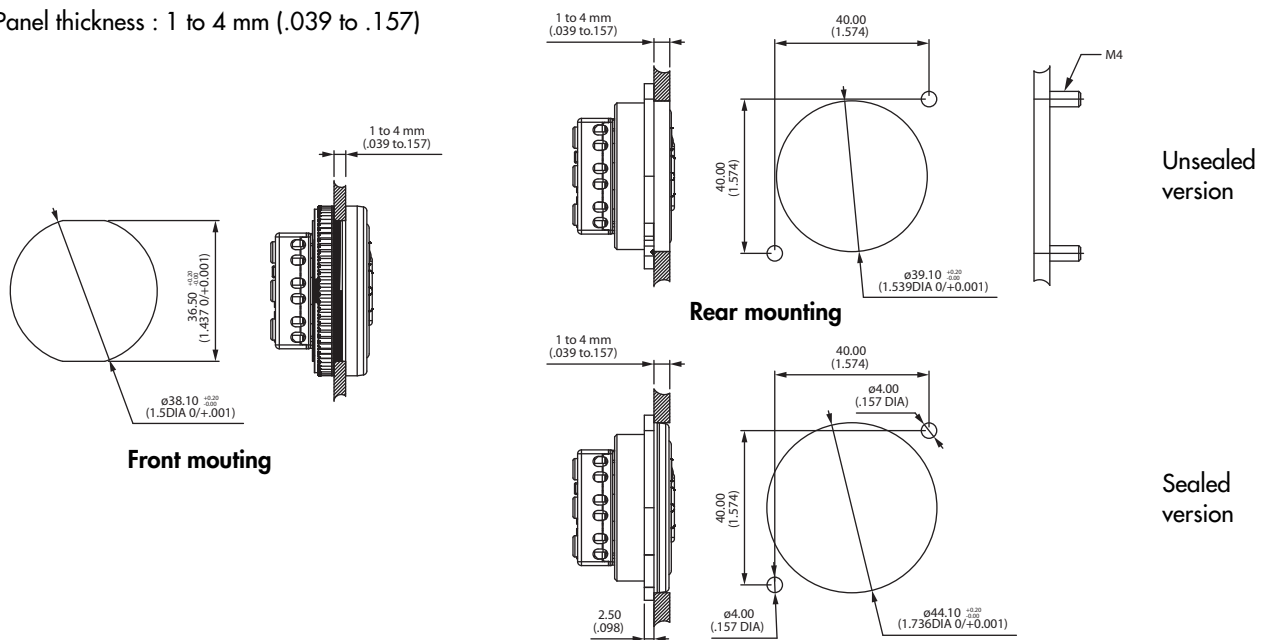

LPI series

Tactile pushbutton switches with large actuator

Overview

SWITCH BLOCK

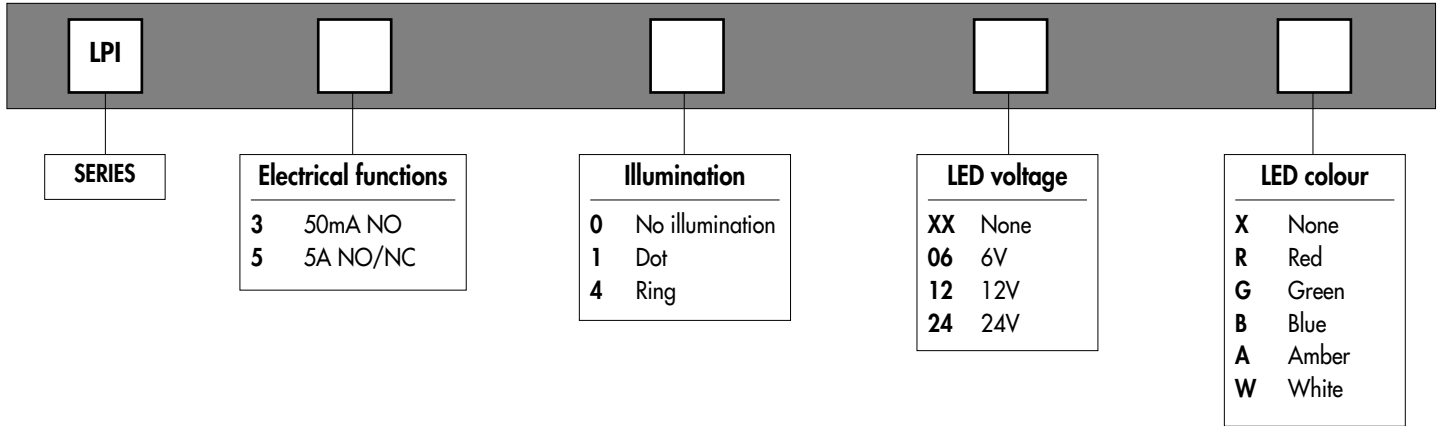

OPERATOR

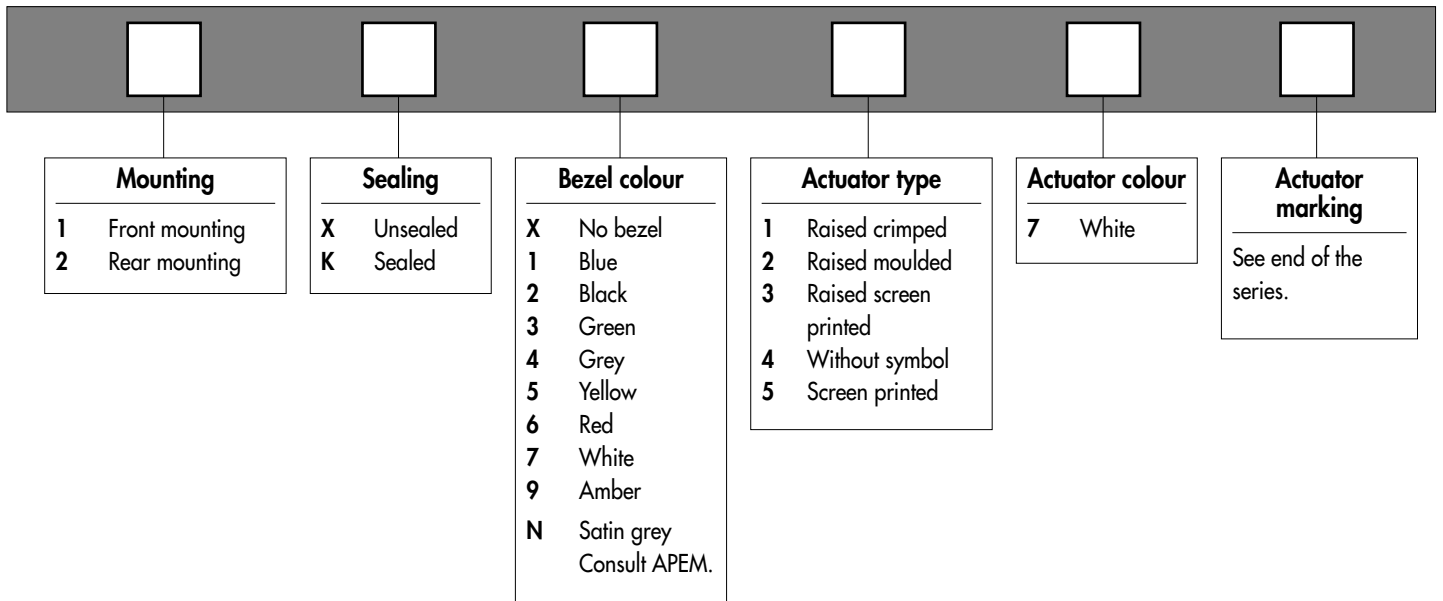

ABOUT THIS SERIES

On the following pages, you will find successively switch block order numbers and operator order numbers.

Dimensions : first dimensions are in m while inches are shown as bracketed numbers.



NOTICE : please note that not all combinations of above numbers are available. Refer to the following pages for further information.



Packaging unit : 15 pieces for front mounting versions - 20 pieces for rear mounting versions.



Sealing boot available to increase the sealing of LPI switches. See section H.

LPI series

Tactile pushbutton switches with large actuator

Switch block

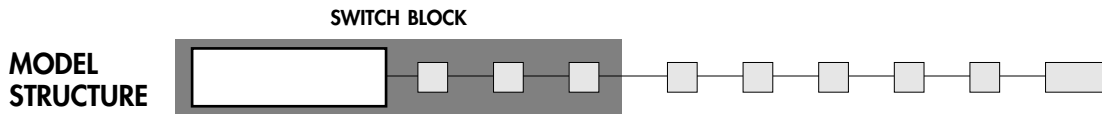

5A momentary NC/NO combined



LPI5

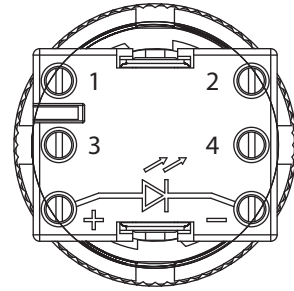
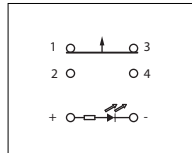

Terminal block

Wire size : AWG20-15 - 0,5 to 1,5 mm²

Rated torque : 0,5 Nm

Screw size : M3

50mA momentary NO



LPI3

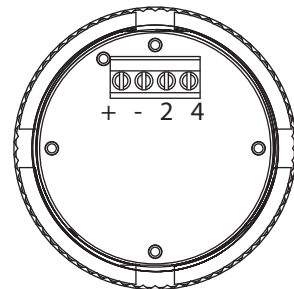
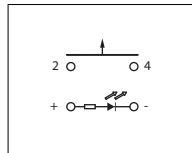

Terminal block

Wire size : AWG28-16 - 0,5 to 1 mm²

Rated torque : 0,4 Nm

Screw size : M2

B2

LPI series

Tactile pushbutton switches with large actuator

Switch block

ILLUMINATION

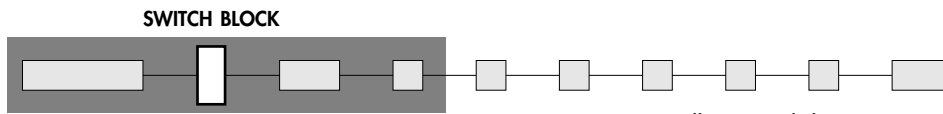

- 0 Non-illuminated
- 1 Illuminated dot (1 LED)
- 4 Illuminated ring (4 LEDs)

Option 4 available only in the case of screen-printed symbol

Illuminated dot



Option 1

Illuminated ring



Option 4

LED VOLTAGE

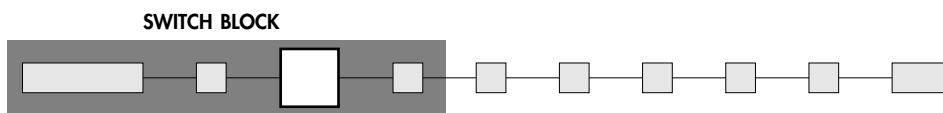

- XX Non-illuminated
- 06 6V
- 12 12V
- 24 24V



Combination with other options : see table below.

- Integrated resistors
- LED current : 20mA typical for dot or ring (30mA max.)
- LEDs protected from reverse polarity
- Stand-by consumption for illuminated product : 0,5VA max.

LED COLOUR

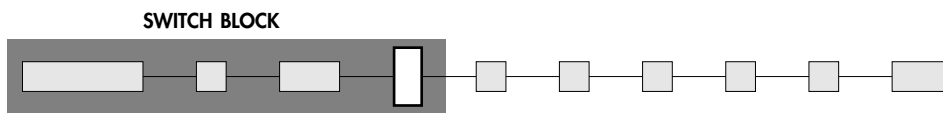

- X Non-illuminated
- R Red
- G Green
- A Amber
- B Blue
- W White

For illuminated ring, see table opposite.

Colours available with illuminated ring (option 4)

	Red	Green	Amber	Blue	White
LED voltage	Version 5A				
6V	No	No	No	No	No
12V	Yes	Yes	No	No	No
24V	Yes	Yes	Yes	Yes	Yes
LED voltage	Version 50mA				
6V	No	No	No	No	No
12V	Yes	No	Yes	No	No
24V	Yes	Yes	Yes	Yes	Yes@

LPI series

Tactile pushbutton switches with large actuator

Operator

MOUNTING

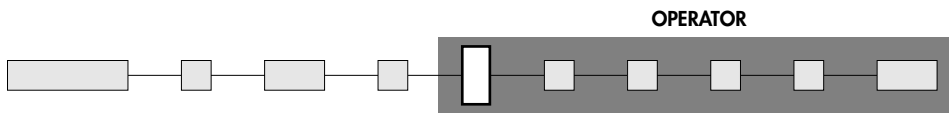

- 1 Front mounting
- 2 Rear mounting

FRONT MOUNTING - 50mA version

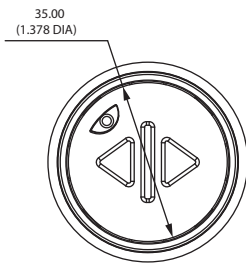
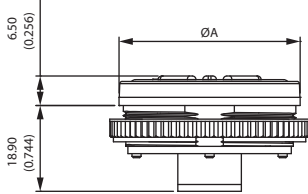

FRONT MOUNTING - 5A version

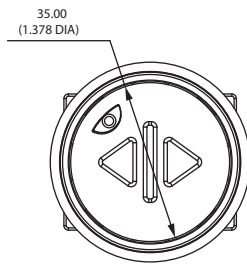
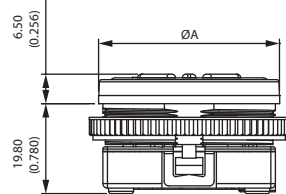

REAR MOUNTING - all versions

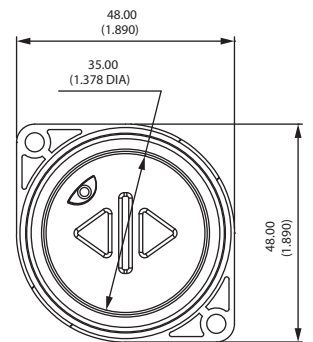
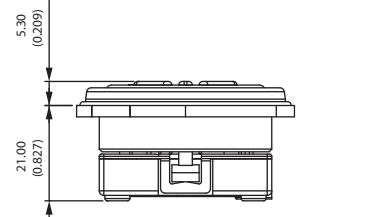

MATRIX MOUNTING

All versions

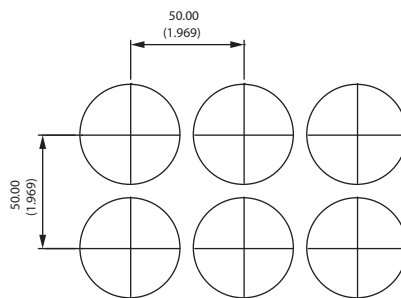

Dimension A

Sealed models : 44 mm (1.732)

Unsealed models : 39,9 mm (1.570)

SEALING

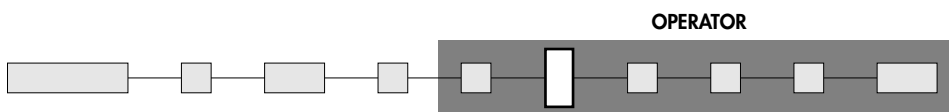

- X Unsealed
- K Sealed

Note : bezel compulsory on sealed versions.

LPI series

Tactile pushbutton switches with large actuator

Operator

BEZEL COLOUR

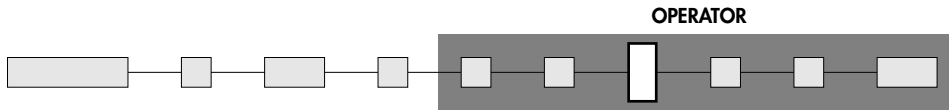

- X No bezel
- 1 Blue
- 2 Black
- 3 Green
- 4 Grey
- 5 Yellow
- 6 Red
- 7/1 White
- 9 Orange



Satin grey (option N) : consult APEM.

For sealed versions, the bezel is compulsory.

ACTUATOR TYPE

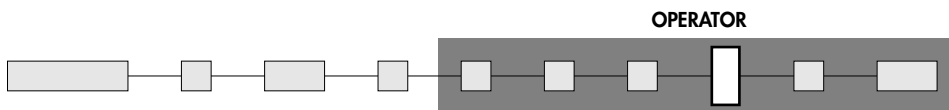

- 1 Stainless steel raised crimped symbol
- 2 Raised moulded symbol (star and bell)
- 3 Raised screen printed symbol
- 4 Without symbol
- 5 Screen printed symbol

Ring illumination available with options 3, 4 and 5 only.

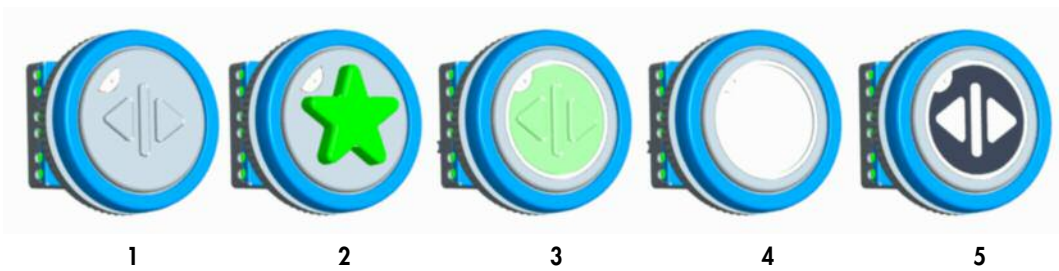

ACTUATOR COLOR

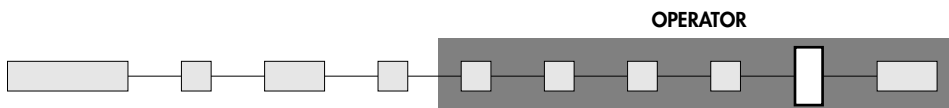

- 7 White



LPI series

Tactile pushbutton switches with large actuator

Operator

ACTUATOR MARKING

OPERATOR

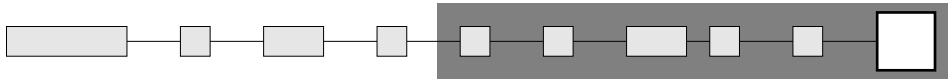

CODE	SYMBOL	DESCRIPTION
XX	/	No symbol
00	0	
01	1	
02	2	
03	3	
04	4	
05	5•	With single tactile point
06	6	
07	7	
08	8	
09	9	
11	-1	
12	-2	
13	-3	

CODE	SYMBOL	DESCRIPTION
14	◀▶	Open
15	▶◀	Close
16	△	Up
17	▽	Down
18	◁	Left
19	▷	Right
20	☼	Ventilation
21	🔔	Alarm (moulded, yellow)
22	★	Exit level (moulded, green)
23	☎	Phone

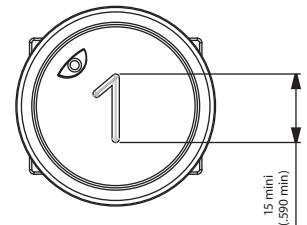
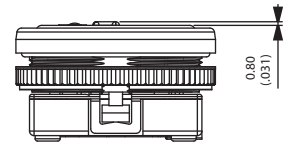

Actuator type 1

	Symbol height		
	Symbol 21	Symbol 22	Other symbol
Actuator type 1	x	x	0,8 mm
Actuator type 2	0,8 mm	5 mm	x
Actuator type 3	x	x	0,8 mm
Actuator type 4	x	x	x
Actuator type 5	x	x	0 mm

x = non available